

MODELLO APERTURA A BILICO

Caratteristiche materiali della finestra

Telaio e battente in legno:

- abete nordico massiccio
- impregnante antimuffa e antitarlo
- verniciatura a base acqua

Conversa e cornice esterne:

- alluminio preverniciato
- rame naturale

INSTALLABILE CON PENDENZE 12° -90°

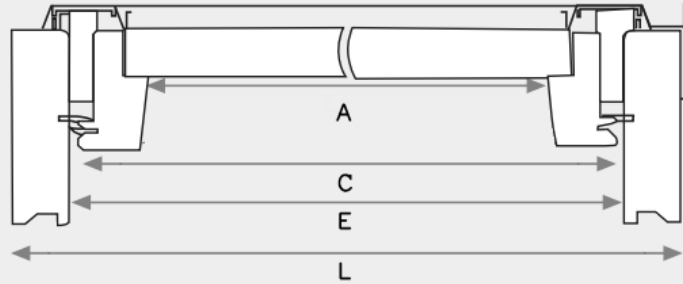
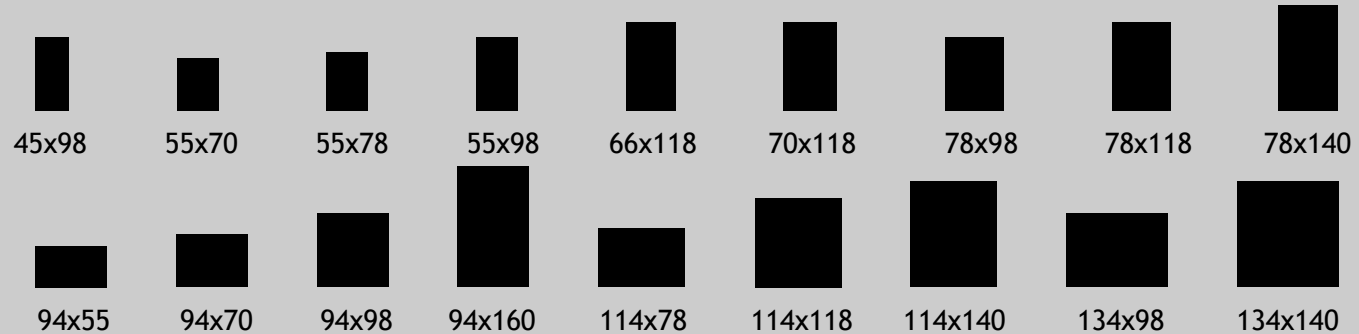

REALIZZAZIONI ANCHE SU MISURA

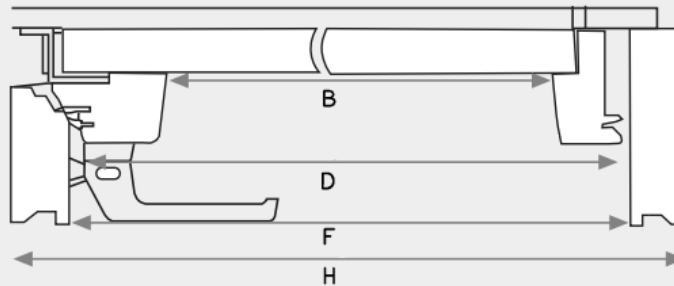

Dimensioni nominali

Foro muratura

Area vetrata

Battente interno

Battente esterno

Telaio interno

Telaio esterno

Superficie

Peso

L	450	550	550	450	550	660	700	780	780	780	940	940	940	940	1140	1140	1340	1340
H	980	700	780	980	980	1180	1180	980	1180	1400	550	700	980	1600	1180	1400	980	1400
L	460	560	560	460	560	670	710	790	790	790	950	950	950	950	1150	1150	1350	1350
H	990	710	790	990	990	1190	1190	990	1190	1410	560	710	990	1610	1190	1410	990	1410
	0,24 Mq.	0,21 Mq.	0,24 Mq.	0,24 Mq.	0,32 Mq.	0,51 Mq.	0,55 Mq.	0,51 Mq.	0,63 Mq.	0,77 Mq.	0,30 Mq.	0,43 Mq.	0,64 Mq.	1,12 Mq.	1,00 Mq.	1,29 Mq.	0,97 Mq.	1,47 Mq.
A	288	388	388	288	388	498	538	618	618	618	778	778	778	778	978	978	1178	1178
B	818	538	618	818	818	1018	1018	818	1018	1238	388	538	818	1438	1018	1238	818	1238
C	376	476	476	376	476	586	626	706	706	706	866	866	866	866	1066	1066	1266	1266
D	906	626	706	906	906	1106	1106	906	1106	1326	476	626	906	1526	1106	1326	906	1326
E	386	486	486	386	486	596	636	716	716	716	876	876	876	876	1076	1076	1276	1276
F	916	636	716	916	916	1116	1116	916	1116	1336	486	636	916	1536	1116	1336	916	1336
L	450	550	550	450	550	660	700	780	780	780	940	940	940	940	1140	1140	1340	1340
H	980	700	780	980	980	1180	1180	980	1180	1400	550	700	980	1600	1180	1400	980	1400
	0,37 Mq.	0,325 Mq.	0,365 Mq.	0,372 Mq.	0,465 Mq.	0,666 Mq.	0,734 Mq.	0,678 Mq.	0,806 Mq.	0,985 Mq.	0,431 Mq.	0,580 Mq.	0,827 Mq.	1,379 Mq.	1,230 Mq.	1,425 Mq.	1,199 Mq.	1,740 Mq.
KG	22	19	21	22	25	31	34	31	37	43	25	26	37	56	48	55	47	62

MODELLO APERTURA A VASISTAS

Caratteristiche materiali della finestra

Telaio e battente in legno:

- abete nordico massiccio
- impregnante antimuffa e antitarlo
- verniciatura a base acqua

Conversa e cornice esterne:

- alluminio preverniciato
- rame naturale

INSTALLABILE CON PENDENZE 12° -90°



45x98	55x78	55x98	66x118	70x118	78x98	78x140
94x98	94x160	114x118	114x140	134x98	134x140	

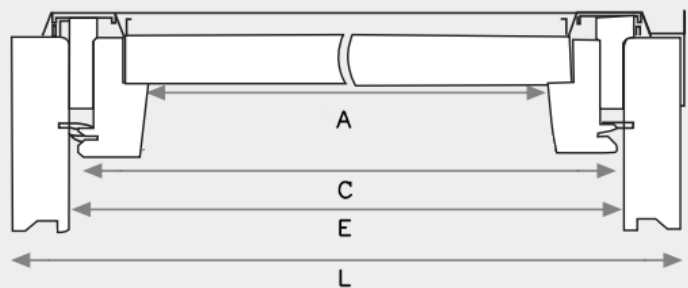

REALIZZAZIONI ANCHE SU MISURA

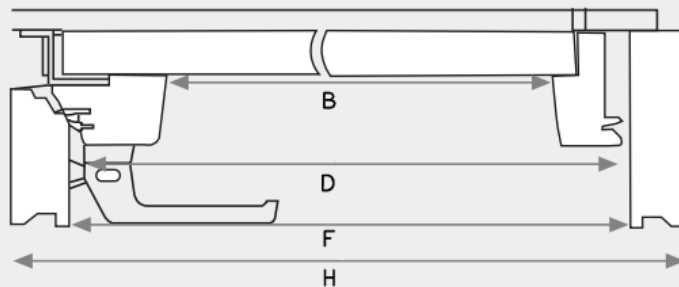

Dimensioni nominali

Foro muratura

Area vetrata

Battente interno

Battente esterno

Telaio interno

Telaio esterno

Superficie

Peso

L	450	550	550	450	550	660	700	780	780	780	940	940	940	940	1140	1140	1340	1340	
H	980	700	780	980	980	1180	1180	980	1180	1400	550	700	980	1600	1180	1400	980	1400	
L	460	560	560	460	560	670	710	790	790	790	950	950	950	950	1150	1150	1350	1350	
H	990	710	790	990	990	1190	1190	990	1190	1410	560	710	990	1610	1190	1410	990	1410	
	0,24	0,21	0,24	0,24	0,32	0,51	0,55	0,51	0,63	0,77	0,30	0,43	0,64	1,12	1,00	1,29	0,97	1,47	
	Mq.	Mq.	Mq.	Mq.	Mq.	Mq.	Mq.	Mq.	Mq.	Mq.	Mq.	Mq.	Mq.	Mq.	Mq.	Mq.	Mq.	Mq.	Mq.
A	288	388	388	288	388	498	538	618	618	618	778	778	778	778	978	978	1178	1178	
B	818	538	618	818	818	1018	1018	818	1018	1238	388	538	818	1438	1018	1238	818	1238	
C	376	476	476	376	476	586	626	706	706	706	866	866	866	866	1066	1066	1266	1266	
D	906	626	706	906	906	1106	1106	906	1106	1326	476	626	906	1526	1106	1326	906	1326	
E	386	486	486	386	486	596	636	716	716	716	876	876	876	876	1076	1076	1276	1276	
F	916	636	716	916	916	1116	1116	916	1116	1336	486	636	916	1536	1116	1336	916	1336	
L	450	550	550	450	550	660	700	780	780	780	940	940	940	940	1140	1140	1340	1340	
H	980	700	780	980	980	1180	1180	980	1180	1400	550	700	980	1600	1180	1400	980	1400	
	0,37	0,325	0,365	0,372	0,465	0,666	0,734	0,678	0,806	0,985	0,431	0,580	0,827	1,379	1,230	1,425	1,199	1,740	
	Mq.	Mq.	Mq.	Mq.	Mq.	Mq.	Mq.	Mq.	Mq.	Mq.	Mq.	Mq.	Mq.	Mq.	Mq.	Mq.	Mq.	Mq.	Mq.
KG	22	19	21	22	25	31	34	31	37	43	25	26	37	56	48	55	47	62	

MODELLO TRIPLICE APERTURA

Caratteristiche materiali della finestra

Telaio e battente in legno:

- abete nordico massiccio
- impregnante antimuffa e antitarlo
- verniciatura a base acqua

Conversa e cornice esterne:

- alluminio preverniciato
- rame naturale

INSTALLABILE CON PENDENZE 8° -90°

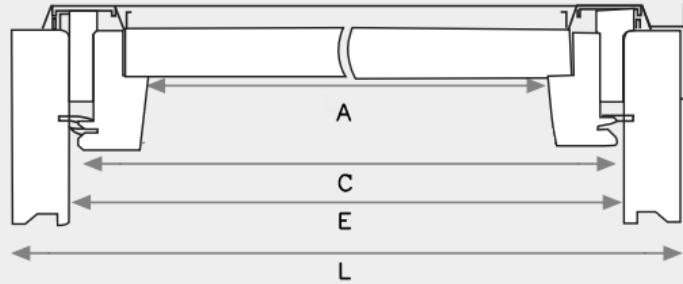
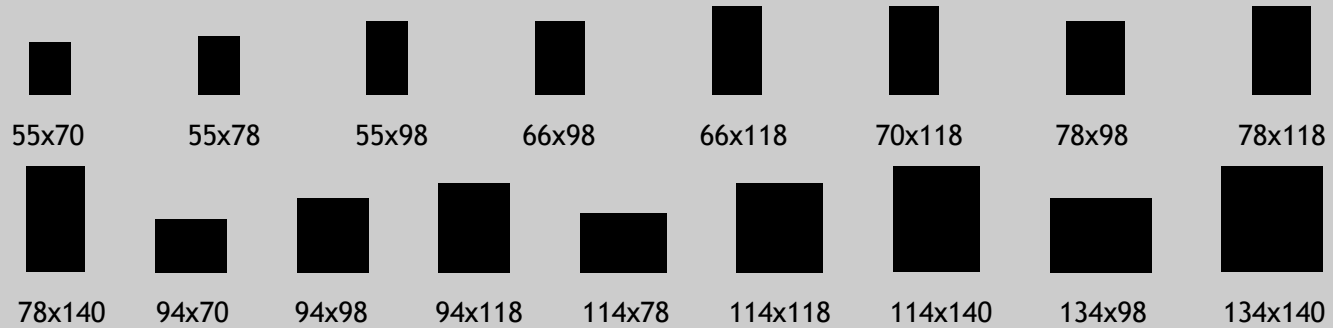

REALIZZAZIONI ANCHE SU MISURA

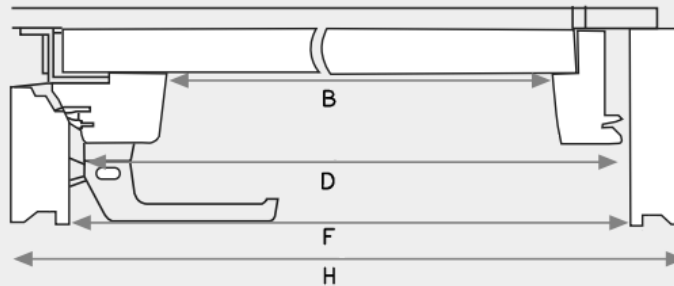

Dimensioni nominali

Foro muratura

Area vetrata

Battente interno

Battente esterno

Telaio interno

Telaio esterno

Superficie

Peso

L	450	550	550	450	550	660	700	780	780	780	940	940	940	940	1140	1140	1340	1340
H	980	700	780	980	980	1180	1180	980	1180	1400	550	700	980	1600	1180	1400	980	1400
L	460	560	560	460	560	670	710	790	790	790	950	950	950	950	1150	1150	1350	1350
H	990	710	790	990	990	1190	1190	990	1190	1410	560	710	990	1610	1190	1410	990	1410
	0,24 Mq.	0,21 Mq.	0,24 Mq.	0,24 Mq.	0,32 Mq.	0,51 Mq.	0,55 Mq.	0,51 Mq.	0,63 Mq.	0,77 Mq.	0,30 Mq.	0,43 Mq.	0,64 Mq.	1,12 Mq.	1,00 Mq.	1,29 Mq.	0,97 Mq.	1,47 Mq.
A	288	388	388	288	388	498	538	618	618	618	778	778	778	778	978	978	1178	1178
B	818	538	618	818	818	1018	1018	818	1018	1238	388	538	818	1438	1018	1238	818	1238
C	376	476	476	376	476	586	626	706	706	706	866	866	866	866	1066	1066	1266	1266
D	906	626	706	906	906	1106	1106	906	1106	1326	476	626	906	1526	1106	1326	906	1326
E	386	486	486	386	486	596	636	716	716	716	876	876	876	876	1076	1076	1276	1276
F	916	636	716	916	916	1116	1116	916	1116	1336	486	636	916	1536	1116	1336	916	1336
L	450	550	550	450	550	660	700	780	780	780	940	940	940	940	1140	1140	1340	1340
H	980	700	780	980	980	1180	1180	980	1180	1400	550	700	980	1600	1180	1400	980	1400
	0,37 Mq.	0,325 Mq.	0,365 Mq.	0,372 Mq.	0,465 Mq.	0,666 Mq.	0,734 Mq.	0,678 Mq.	0,806 Mq.	0,985 Mq.	0,431 Mq.	0,580 Mq.	0,827 Mq.	1,379 Mq.	1,230 Mq.	1,425 Mq.	1,199 Mq.	1,740 Mq.
KG	22	19	21	22	25	31	34	31	37	43	25	26	37	56	48	55	47	62

MODELLO APERTURA A BILICO OLLY

Caratteristiche materiali della finestra

Telaio e battente in legno:

- abete nordico massiccio
- impregnante antimuffa e antitarlo

Conversa e cornice esterne:

- alluminio preverniciato
- rame naturale

INSTALLABILE CON PENDENZE 8° - 15°



45x98



55x78



55x98



66x118



78x98



78x118



94x70

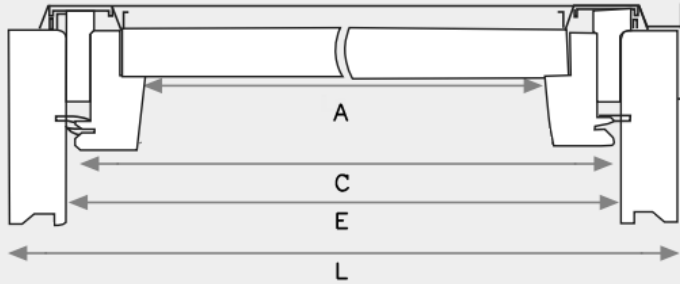

REALIZZAZIONI ANCHE SU MISURA

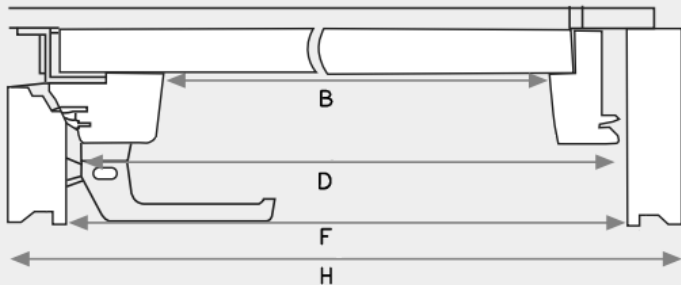

Dimensioni nominali

L	450	450	450	480	550	660	780	780	880	940	1000
H	550	750	980	800	780	1180	980	1180	450	700	500

Foro muratura

L	460	460	460	490	560	670	790	790	890	950	1010
H	560	760	990	810	790	1190	990	1190	460	710	510

Area vetrata

	0,17 Mq.	0,241 Mq.	0,327 Mq.	0,280 Mq.	0,323 Mq.	0,628 Mq.	0,618 Mq.	0,757 Mq.	0,292 Mq.	0,523 Mq.	0,382 Mq.
--	----------	-----------	-----------	-----------	-----------	-----------	-----------	-----------	-----------	-----------	-----------

Battente interno

A	363	363	363	393	463	573	693	693	793	853	913
B	463	663	893	713	693	1093	893	1093	363	613	413

Battente esterno

C	450	450	450	480	550	660	780	780	880	940	1000
D	550	750	980	800	780	1180	980	1180	450	700	500

Telaio interno

E	412	412	412	442	512	622	742	742	842	962	902
F	512	712	942	762	742	1142	942	1142	412	462	662

Superficie apribile

	0,21 Mq.	0,290 Mq.	0,385 Mq.	0,336 Mq.	0,380 Mq.	0,706 Mq.	0,695 Mq.	0,847 Mq.	0,344 Mq.	0,444 Mq.	0,597 Mq.
--	----------	-----------	-----------	-----------	-----------	-----------	-----------	-----------	-----------	-----------	-----------

Peso

KG	12	14	17	16	17	26	24	28	17	18	25
----	----	----	----	----	----	----	----	----	----	----	----

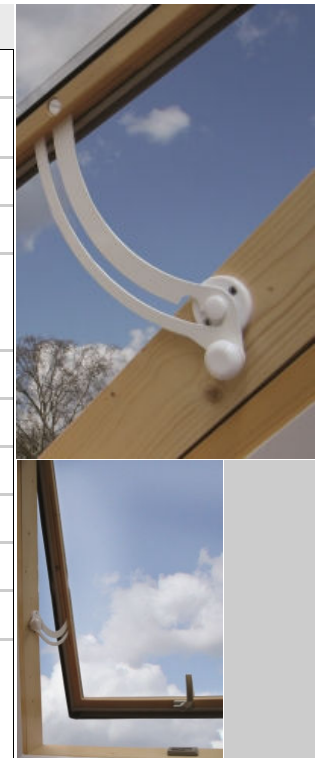

MODELLO APERTURA A VASISTAS EXP

Caratteristiche materiali della finestra

Telaio e battente in legno:

- abete nordico massiccio
- impregnante antimuffa e antitarlo

Conversa e cornice esterne:

- alluminio preverniciato
- rame naturale

INSTALLABILE CON PENDENZE 8° - 15°

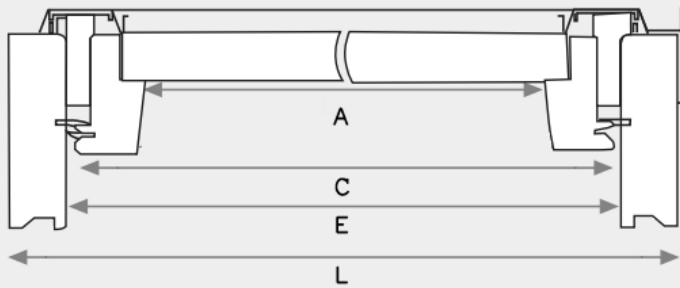

REALIZZAZIONI ANCHE SU MISURA

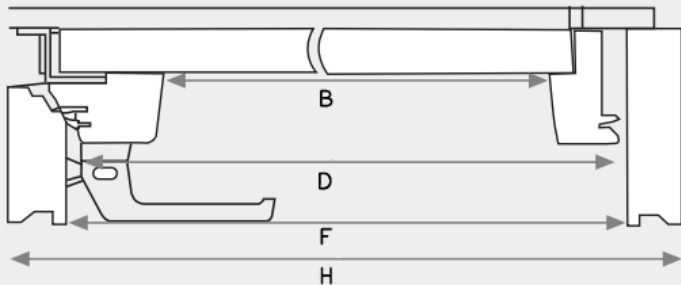

Dimensioni nominali

L	450	450	450	480	550	660	780	780	880	940	1000
H	550	750	980	800	780	1180	980	1180	450	700	500

Foro muratura

L	460	460	460	490	560	670	790	790	890	950	1010
H	560	760	990	810	790	1190	990	1190	460	710	510

Area vetrata

	0,17 Mq.	0,241 Mq.	0,327 Mq.	0,280 Mq.	0,323 Mq.	0,628 Mq.	0,618 Mq.	0,757 Mq.	0,292 Mq.	0,523 Mq.	0,382 Mq.
--	----------	-----------	-----------	-----------	-----------	-----------	-----------	-----------	-----------	-----------	-----------

Battente interno

A	363	363	363	393	463	573	693	693	793	853	913
B	463	663	893	713	693	1093	893	1093	363	613	413

Battente esterno

C	450	450	450	480	550	660	780	780	880	940	1000
D	550	750	980	800	780	1180	980	1180	450	700	500

Telaio interno

E	412	412	412	442	512	622	742	742	842	962	902
F	512	712	942	762	742	1142	942	1142	412	462	662

Superficie apribile

	0,21 Mq.	0,290 Mq.	0,385 Mq.	0,336 Mq.	0,380 Mq.	0,706 Mq.	0,695 Mq.	0,847 Mq.	0,344 Mq.	0,444 Mq.	0,597 Mq.
--	----------	-----------	-----------	-----------	-----------	-----------	-----------	-----------	-----------	-----------	-----------

Peso

KG	12	14	17	16	17	26	24	28	17	18	25
----	----	----	----	----	----	----	----	----	----	----	----



MODELLO APERTURA A LIBRO

Caratteristiche materiali della finestra

Telaio e battente in legno:

- abete nordico massiccio
- impregnante antimuffa e antitarlo

Conversa e cornice esterne:

- alluminio preverniciato
- rame naturale

INSTALLABILE CON PENDENZE 8° - 15°

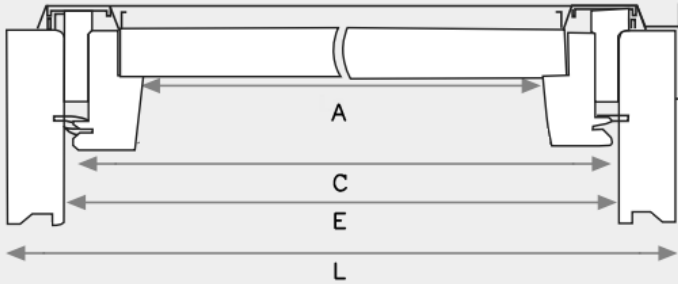
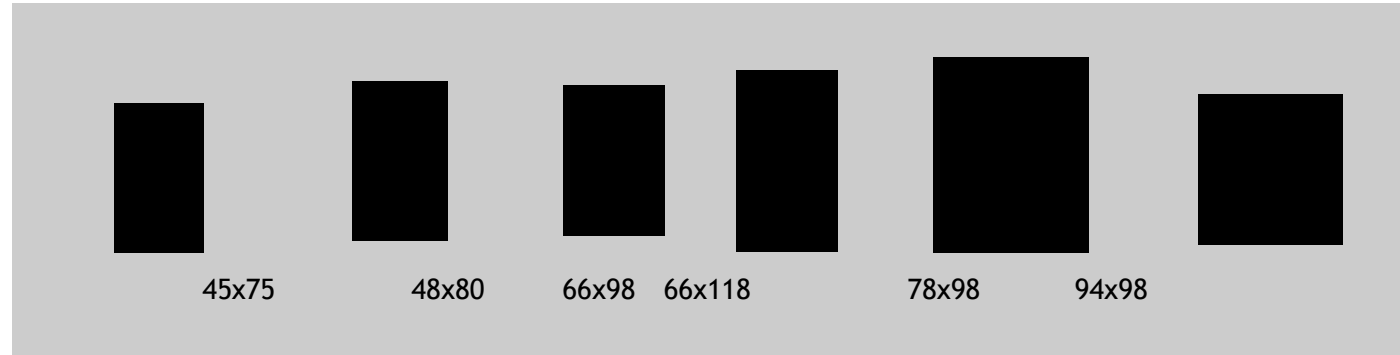

REALIZZAZIONI ANCHE SU MISURA

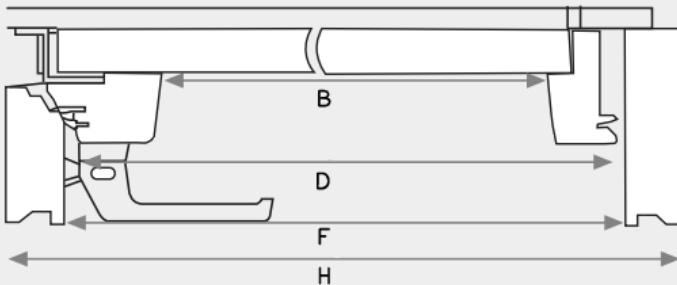

Dimensioni nominali	L	450	450	450	480	550	660	780	780	880	940	1000
	H	550	750	980	800	780	1180	980	1180	450	700	500
Foro muratura	L	460	460	460	490	560	670	790	790	890	950	1010
	H	560	760	990	810	790	1190	990	1190	460	710	510
Area vetrata		0,17 Mq.	0,241 Mq.	0,327 Mq.	0,280 Mq.	0,323 Mq.	0,628 Mq.	0,618 Mq.	0,757 Mq.	0,292 Mq.	0,523 Mq.	0,382 Mq.
Battente interno	A	363	363	363	393	463	573	693	693	793	853	913
	B	463	663	893	713	693	1093	893	1093	363	613	413
Battente esterno	C	450	450	450	480	550	660	780	780	880	940	1000
	D	550	750	980	800	780	1180	980	1180	450	700	500
Telaio interno	E	412	412	412	442	512	622	742	742	842	962	902
	F	512	712	942	762	742	1142	942	1142	412	462	662
Superficie apribile		0,21 Mq.	0,290 Mq.	0,385 Mq.	0,336 Mq.	0,380 Mq.	0,706 Mq.	0,695 Mq.	0,847 Mq.	0,344 Mq.	0,444 Mq.	0,597 Mq.
Peso	KG	12	14	17	16	17	26	24	28	17	18	25

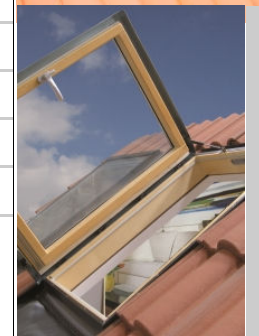

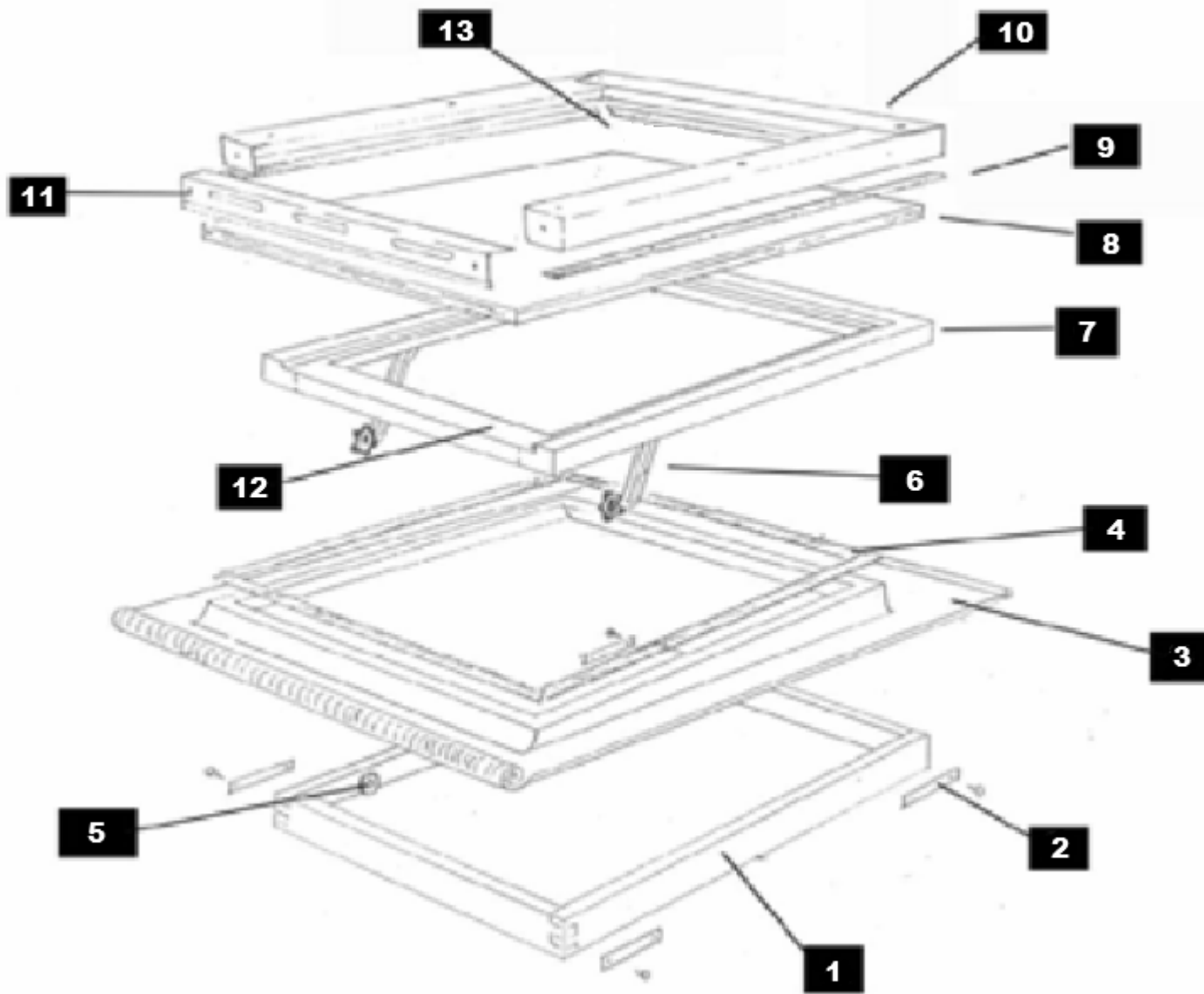

COMPOSIZIONE ABBAINI

1	Telaio
2	Brandella di fissaggio
3	Raccordo
4	Guarnizione adesiva
5	Ruotina guida
6	Braccio di apertura
7	Battente
8	Vetrata
9	Guarnizione
10	Coperchio
11	Profilo fermavetro
12	Profilo sottovetro
13	Cerniere

TIPOLOGIA DI VETRATE



- Base
- Basso emissivo
- Anti-grandine / di sicurezza
- Acustico / Antisfondamento

VERSIONI PVC O VERNICIATE

Il PVC è un materiale che non necessita di manutenzione e garantisce lunga durata nel tempo.



Ampia gamma di accessori: tende, motorizzazioni, tapparelle universali 230V, cupole e tunnel solari. Servizi di assistenza e posa.